



# PROFESSIONAL MANUFACTURER IN LED LIGHTING

**Austar Lighting Co.,Ltd.** is one of leading manufacturers and exporter specialized in outdoor lighting in Ningbo China.The factory is located nearly 50Kms away from Ningbo sea port and 180Kms away from Shanghai sea port which surely trengthen our prompt delivery for your orders.

Our factory covers an area of 12000 sqare meters,,with about 100 employes.We have modern and perfect machines with high technology,there are die-casting line,spray-painting line and seembling line in our company by which we can complete a series of processes such as mould designing and die-casting mechanical tooling and surface dealing and lamp assembling etc. independently.We have lots of modern equipments such as 1250T/900T die-casting machine,80T punch machine,automatic spray-painting line,aluminium die-casting surface dealing facility,lamps assembling lines ets.The technology and quality has reached internation market requirements,most of the products exported to Europe,Asia,South Amerca,Middle-east market etc.

Now we can supply the following lighing products for our customer choice:

- LED Light Series**
- Garden Light Series**
- Street Light Series**
- Bollard Light Series**
- Down Light Series**
- Spot Light Series**
- Stainless Steel Light Series**
- Barrier Light Series**

We also have good reputation from our customers,because they are always satisfied with the high quality of products,soonest delivery lead time and our very good after-sale sevice.We are full of confidence that with the time of flying,AUSTAR LIGHTING this rising new star will create a new world of brightness together with your effort.

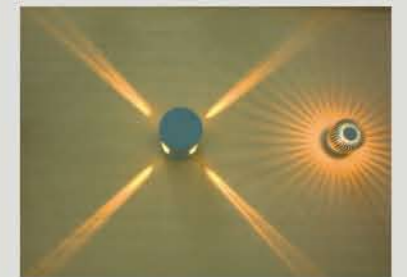
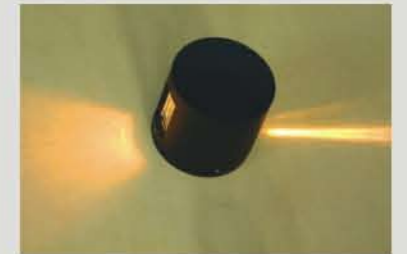
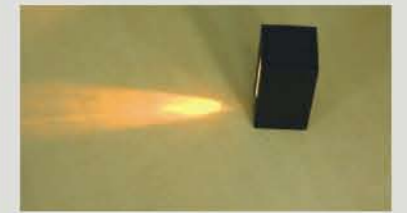
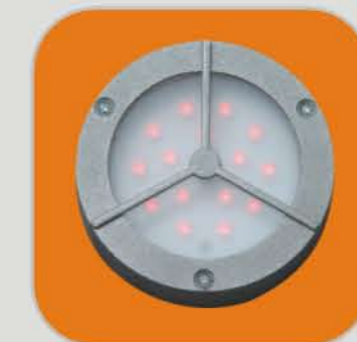

**DESCRIPTION**

Aluminium die-casting body  
Premier crystal lens  
Silicon gasket  
LED Color: white, blue, red, yellow  
Supreme polishing treatment or powder coating  
For both residential and commercial purpose

g	220-240
LEDS	V
F	IP54

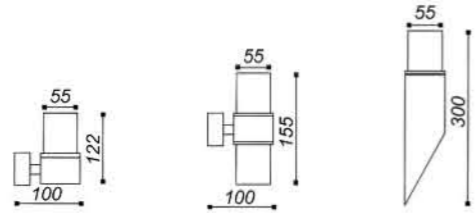

LED-1103

**DESCRIPTION**

Aluminium die-casting body  
Premier crystal lens  
Silicon gasket  
LED Color: white, blue, red, yellow  
Supreme polishing treatment or powder coating  
For both residential and commercial purpose

g	220-240
LEDS	V
F	IP54

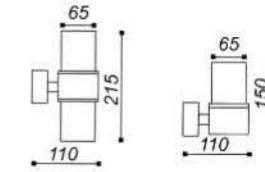

LED-1201



LED-1101



LED-1102



LED-1104



LED-1105



LED-1202



LED-1203

**DESCRIPTION**

Aluminium die-casting body  
Premier crystal lens  
Silicon gasket  
LED Color:white, blue, red, yellow  
Supreme polishing treatment or powder coating  
For both residential and commercial purpose

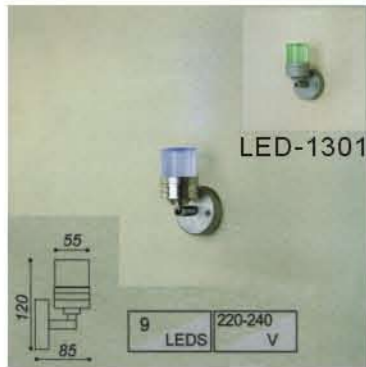
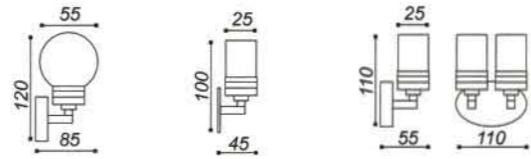

LED-1302

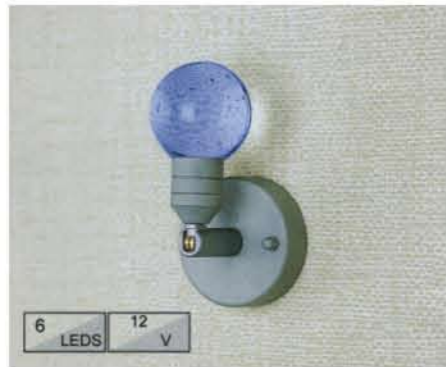

LED-1304



LED-1305



LED-1306

**DESCRIPTION**

Aluminium die-casting body  
Premier crystal lens  
Silicon gasket  
LED Color:white, blue, red, yellow  
Supreme polishing treatment or powder coating  
For both residential and commercial purpose

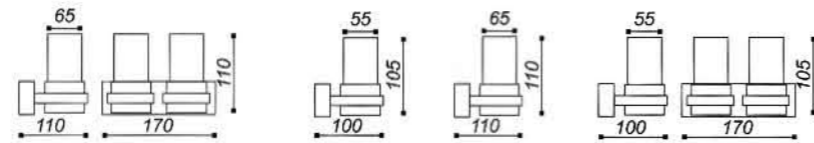

LED-1401



LED-1402



LED-1403

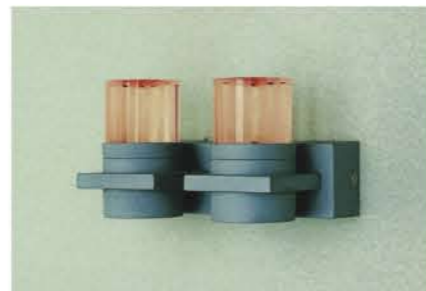

LED-1404

**DESCRIPTION**

Aluminium die-casting body  
Premier crystal lens  
Silicon gasket  
Supply with easy installation clip  
LED Color:white, blue, red, yellow  
Supreme polishing treatment or powder coating  
For both residential and commercial purpose

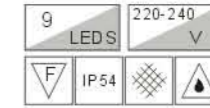

LED-1501

**DESCRIPTION**

Aluminium die-casting body  
Premier crystal lens  
Stainless steel outer frame  
Silicon gasket  
Supply with easy installation clip  
LED Color:white, blue, red, yellow  
Supreme polishing treatment or powder coating  
For both residential and commercial purpose



LED-1502

**DESCRIPTION**

Aluminium die-casting body  
Premier crystal lens  
Stainless steel outer frame  
Silicon gasket  
Supply with easy installation clip  
LED Color:white, blue, red, yellow  
Supreme polishing treatment or powder coating  
For both residential and commercial purpose



LED-1503

**DESCRIPTION**

Aluminium die-casting body  
Premier crystal lens  
Stainless steel outer frame  
Silicon gasket  
Supply with easy installation clip  
LED Color:white, blue, red, yellow  
Supreme polishing treatment or powder coating  
For both residential and commercial purpose



LED-1504

**DESCRIPTION**

Aluminium die-casting body  
Premier crystal lens  
Silicon gasket  
LED Color:white, blue, red, yellow  
Supreme polishing treatment or powder coating  
For both residential and commercial purpose

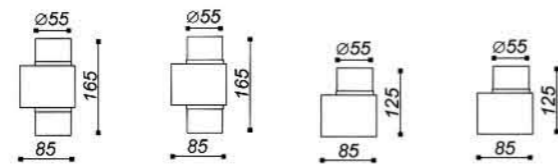

9 LEDs 220-240 V  
IP54



LED-1601



LED-1602



LED-1603



LED-1604

**DESCRIPTION**

Aluminium die-casting body  
Premier crystal lens  
Silicon gasket  
Value-pack available(3pcs fixitures, IP 54 trans fcmer and 10 meters cables)  
LED Color:white, blue, red, yellow  
Supreme polishing treatment or powder coating  
For both residential and commercial purpose

IP54

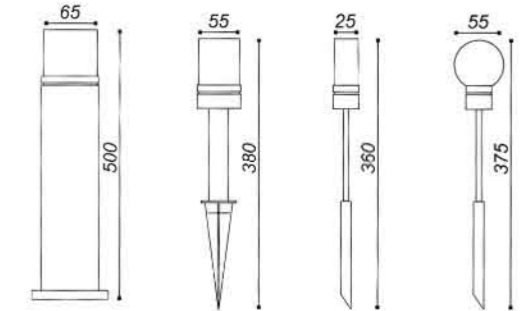

LED-1701



LED-1702



LED-1703



LED-1704

**DESCRIPTION**

Aluminium die-casting body  
Easy-adjustable metal tube  
Value-pack available(3pcs fixitures, IP 54 trans fcmer and 10 meters cables)  
LED Color: white, blue, red, yellow  
Powder coating finish  
For garden, park etc commercial and industrial use

6 LEDs 12 V  
IP54

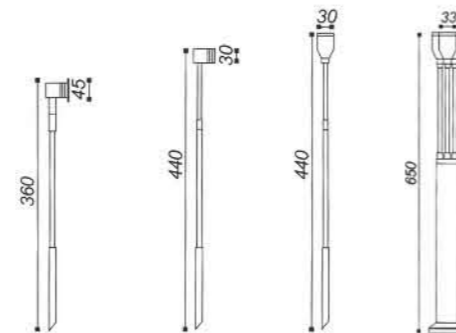

LED-1801



LED-1802



LED-1803



LED-1804



LED-1705



LED-1706



LED-1707

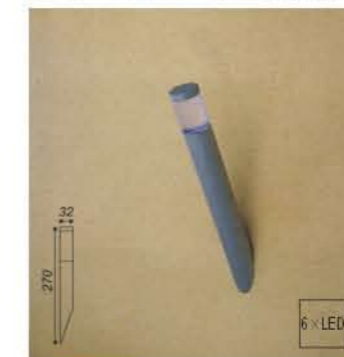

LED-1708

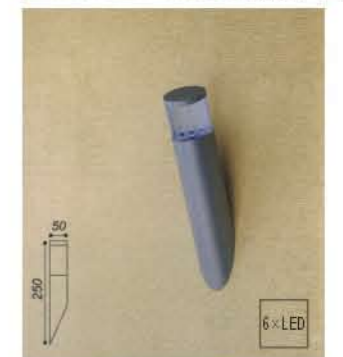

LED-1709

**DESCRIPTION**

Aluminium extrusion body  
 Easy-adjustable metal tube  
 Value-pack available(3pcs fixtures, IP 54 transformer and 10 meters cables)  
 LED Color: white, blue, red, yellow  
 Powder coating finish  
 For garden, park etc commercial and industrial use

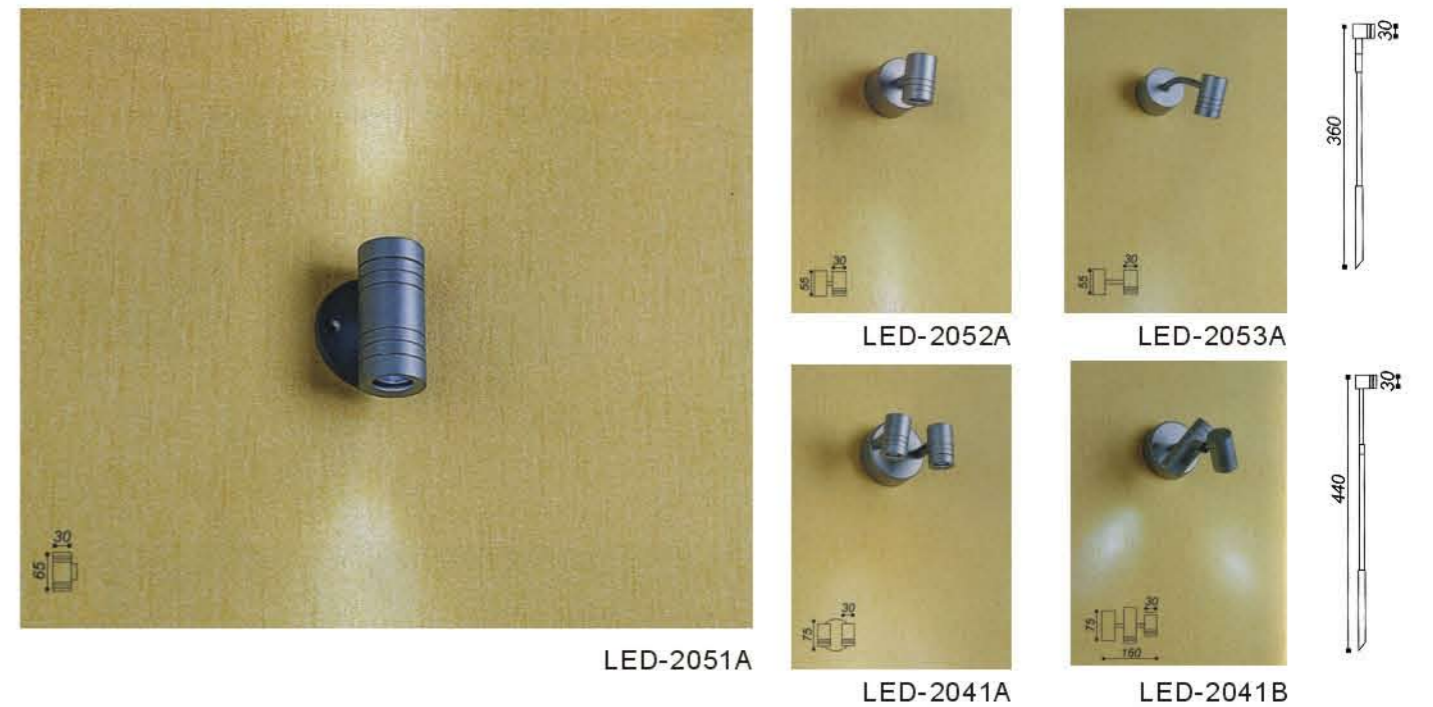
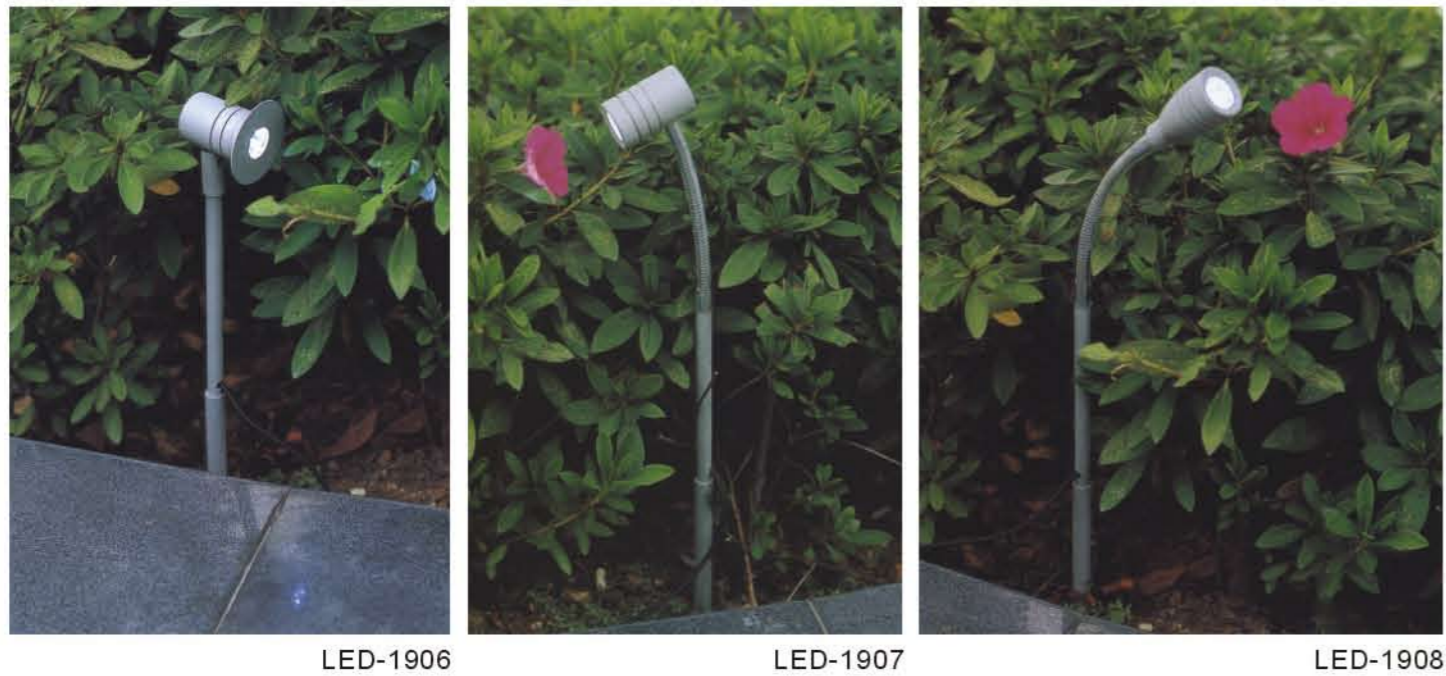
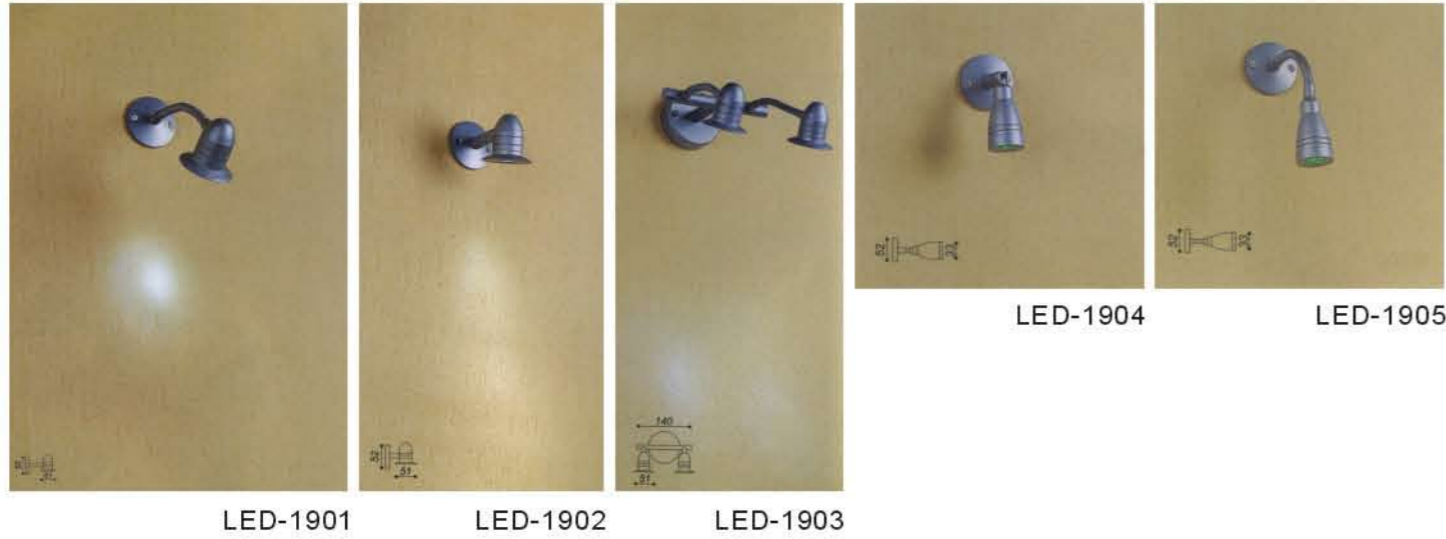
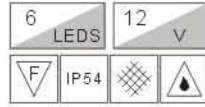

**DESCRIPTION**

Premier aluminium body  
 Designed for high power LED system  
 LED Color:white, blue, red, yellow  
 Supreme polishing treatment + anti corrosion finishing  
 For both residential and commercial purpose  
 Supply with recessed drive-base for direct 220V-240V  
 power input, if choose brightview™ high power LED system

1	6	12	220-240
1W	LEDS	V	V
F	IP54		



LED-2001



LED-2002



LED-2003

**DESCRIPTION**

Premier aluminium body  
 Designed for high power LED system  
 LED Color:white, blue, red, yellow  
 Supreme polishing treatment + anti corrosion finishing  
 For cabinet, window, ect commercial and residential use  
 Supply with recessed drive-base for direct 220V-240V  
 power input, if choose brightview™ high power LED system

1	6	12	220-240
1W	LEDS	V	V
F	IP54		



LED-2011



LED-2012

**DESCRIPTION**

Premier aluminium body  
 Designed for high power LED system  
 LED Color:white, blue, red, yellow  
 Supreme polishing treatment + anti corrosion finishing  
 For cabinet, window, ect commercial and residential use  
 Supply with recessed drive-base for direct 220V-240V  
 power input, if choose brightview™ high power LED system

1	6	12	220-240
1W	LEDS	V	V
F	IP54		



LED-2021



LED-2022



LED-2023

**DESCRIPTION**

Premier aluminium body  
 Designed for high power LED system  
 LED Color:white, blue, red, yellow  
 Supreme polishing treatment + anti corrosion finishing  
 For cabinet, window, ect commercial and residential use  
 Supply with recessed drive-base for direct 220V-240V

1	6	12	220-240
1W	LEDS	V	V
F	IP54		

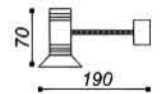
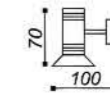
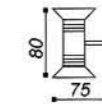
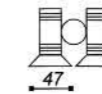

LED-2031



LED-2032



LED-2033



LED-2034

**DESCRIPTION**

Premier aluminium body  
 Designed for high power LED system  
 LED Color:white, blue, red, yellow  
 Supreme polishing treatment + anti corrosion finishing  
 For cabinet, window, ect commercial and residential use  
 Supply with recessed drive-base for direct 220V-240V

1	1W	6	LEDS	12	V	220-240	V
F	IP54						

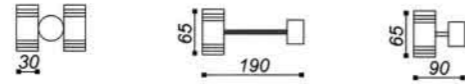

LED-2041      LED-2042      LED-2043      LED-2044

**DESCRIPTION**

Premier aluminium body  
 Designed for high power LED system  
 LED Color:white, blue, red, yellow  
 Supreme polishing treatment + anti corrosion finishing  
 For cabinet, window, ect commercial and residential use  
 Supply with recessed drive-base for direct 220V-240V

1	1W	6	LEDS	12	V	220-240	V
F	IP54						

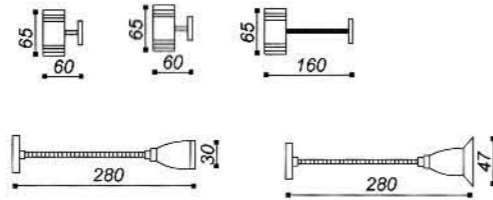

LED-2051      LED-2052      LED-2053      LED-2054      LED-2055

**DESCRIPTION**

Premier aluminium body  
 Designed for high power LED system  
 Superb clear PC diffuser  
 LED Color:white, blue, red, yellow  
 Supreme polishing treatment + anti corrosion finishing  
 For both commercial and residential use  
 Supply with drive-base for direct 220V-240V

6	1W	220-240	V
F	IP54		

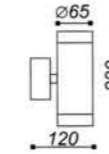

LED-2056

**DESCRIPTION**

Premier aluminium body  
 Frost glass diffuser  
 Silicon gasket  
 G9 or LED  
 LED Color:white, blue, red, yellow, red  
 Powder coating with anti-corrosion feature  
 For both industrial and commercial use

F	IP65				
---	------	--	--	--	--

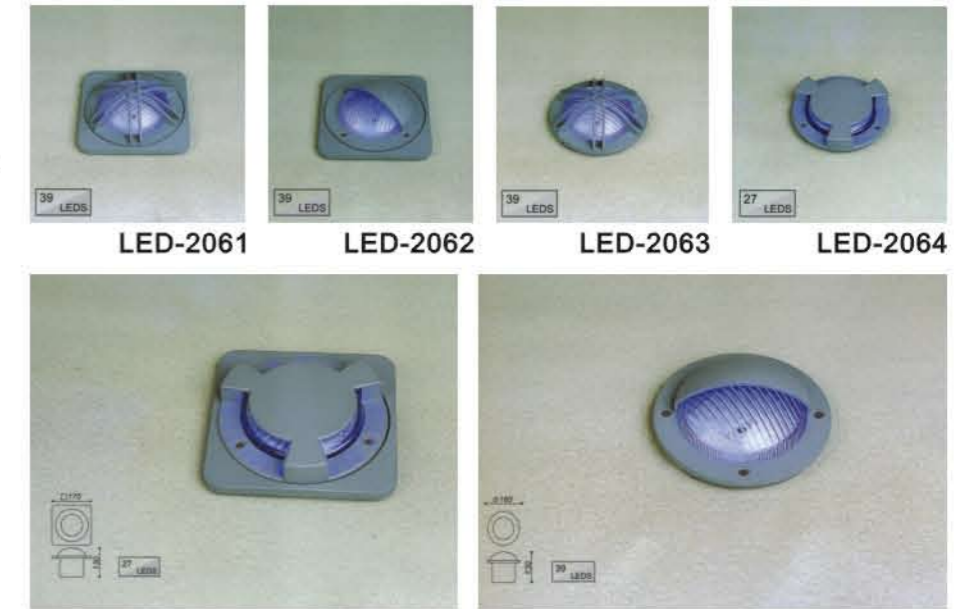

LED-2061      LED-2062      LED-2063      LED-2064

LED-2065      LED-2066



LED-2067



LED-2068

**DESCRIPTION**

Aluminium die casting body  
Clear pc diffuser  
Easy-installtion clip+plastic burial box  
Led color :white, blue, red, yellow  
Anti-corrision powder coating finishing  
For both commercial and residential use

14	220-240
LEDS	V
F	IP54

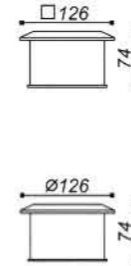

**DESCRIPTION**

Aluminium die casting body  
Clear pc diffuser  
Easy-installtion clip+plastic burial box  
Led color :white, blue, red, yellow  
Anti-corrision powder coating finishing  
For both commercial and redsidential use

F	IP54

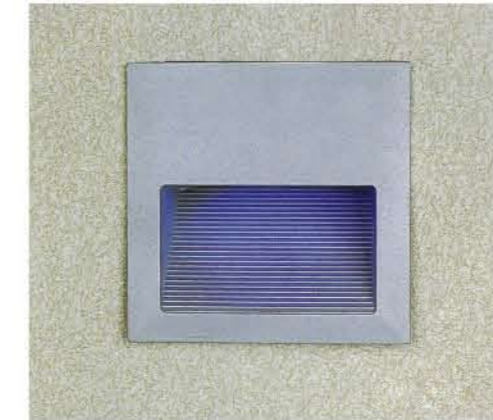
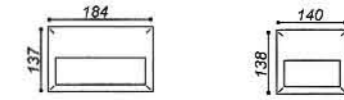

LED-2072

18	220-240
LEDS	V

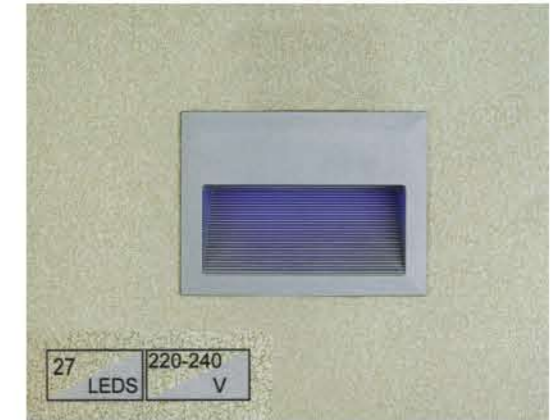

LED-2074



LED-2069

15	220-240
LEDS	V



LED-2070

18	220-240
LEDS	V

**DESCRIPTION**

Aluminium die casting body  
Clear pc diffuser  
Easy-installtion clip+plastic burial box  
Led color :white, blue, red, yellow  
Anti-corrision powder coating finishing  
For both commercial and residential use

F	IP54



**DESCRIPTION**

Aluminium die casting body  
Clear pc diffuser  
Easy-installtion clip+plastic burial box  
Led color :white, blue, red, yellow  
Anti-corrision powder coating finishing  
For both commercial and redsidential use

F	IP54

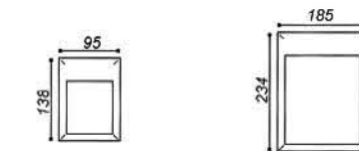

LED-2075

15	220-240
LEDS	V



LED-2076

**DESCRIPTION**

Aluminium die casting body  
Clear pc diffuser  
Easy-installtion clip+plastic burial box  
Led color :white, blue, red, yellow  
Anti-corrision powder coating finishing  
For both commercial and redsidential use

15	220-240
LEDS	V
F	IP54

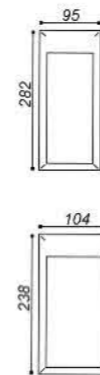

LED-2071



LED-2073



Aluminium 16xLED 1.6W 110V/230V 12V IP54 F CE

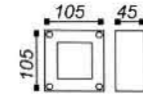

Aluminium LED G9 25W G4 20W 110V/230V 12V IP54 F CE



Aluminium 16xLED 1.5W G9 25W G4 20W 110V/230V 12V IP54 F CE

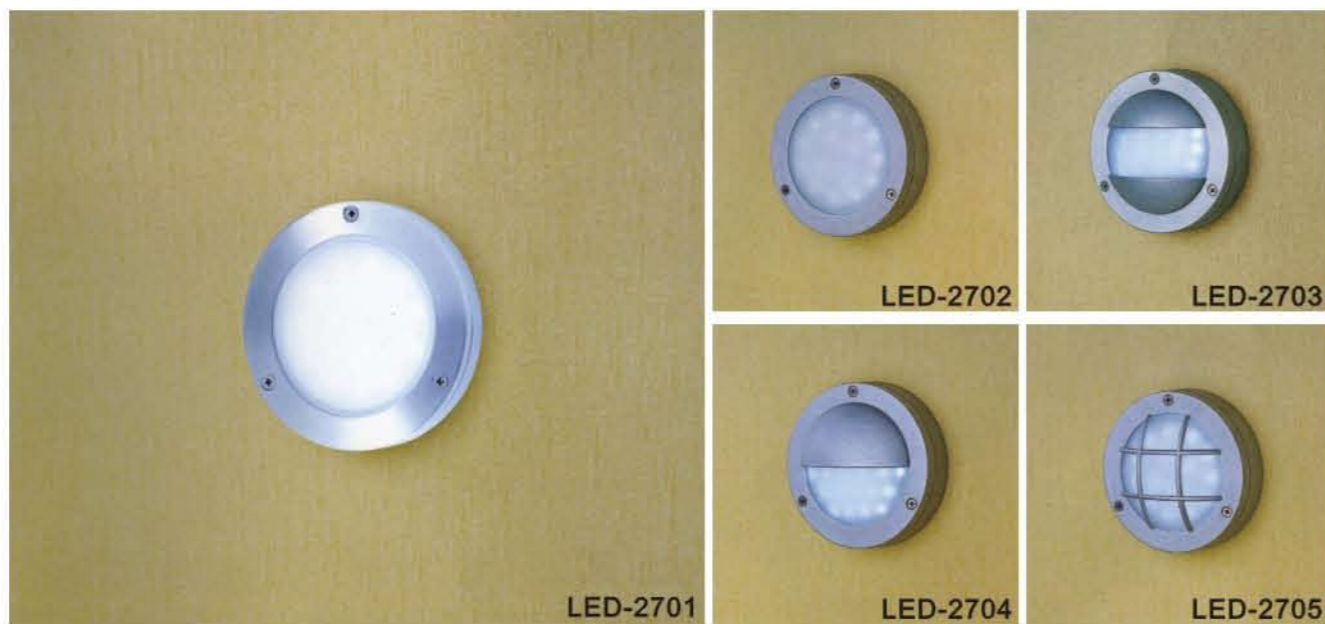
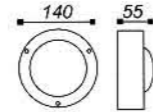

Aluminium 15xLED 1.5W G9 25W G4 20W 110V/230V 12V IP54 F CE

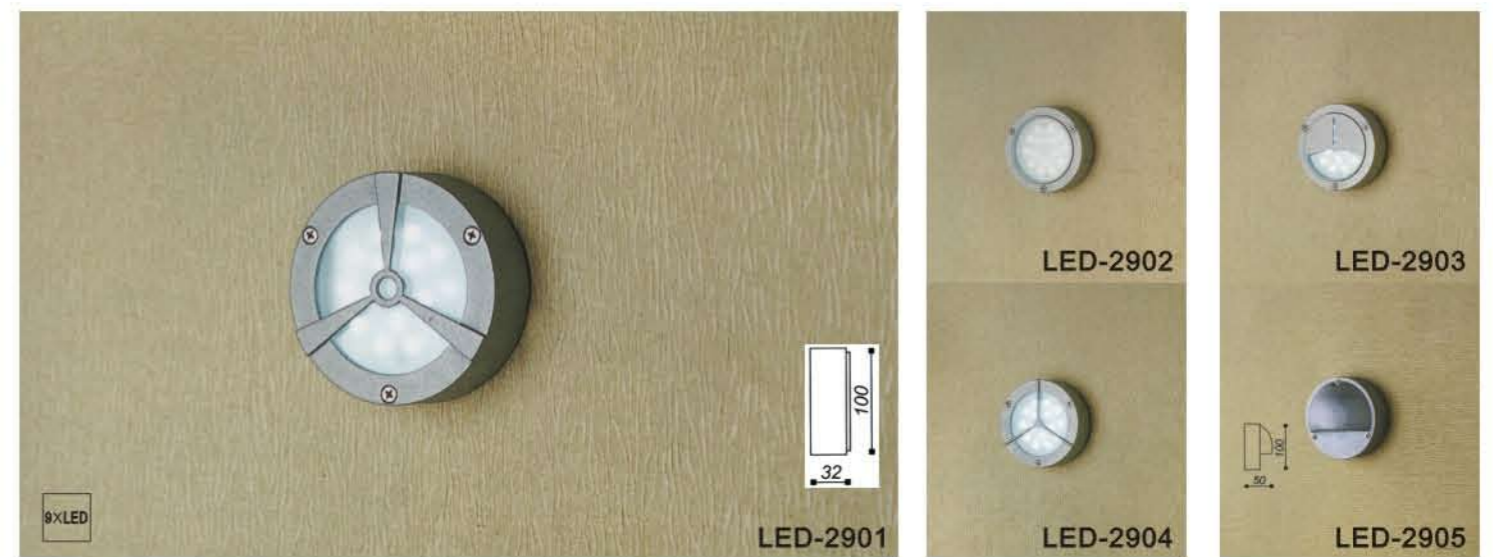

Aluminum 15xLED 1.5W G9 25W G4 20W 110V/230V 12V IP54 F CE



LED-3001



LED-3003

LED-3004

LED-3005

LED-3006

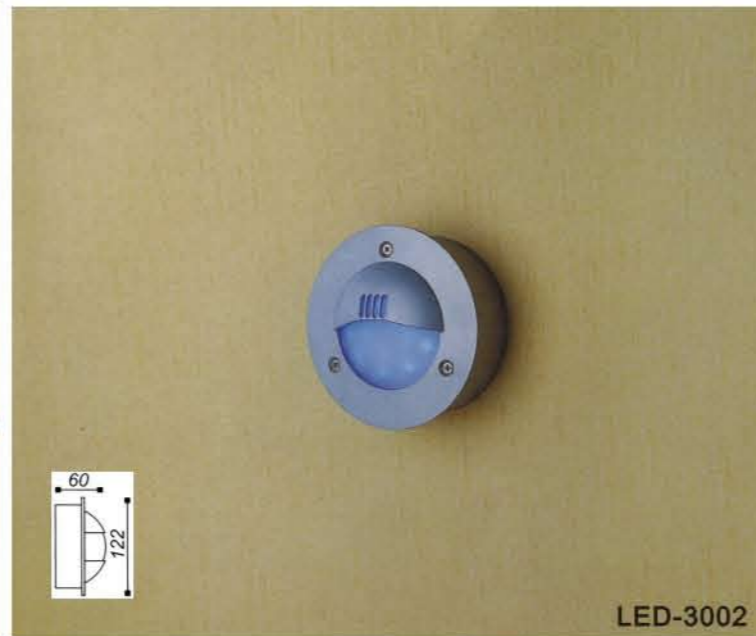

LED-3002

Plastic LED 110V/230V 12V IP65 F CE



LED-3101

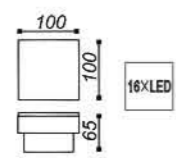

LED-3103

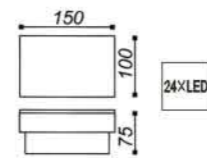

LED-3102

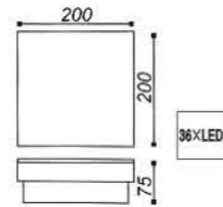

LED-2078



LED-2079



LED-2080

Aluminum LED G9 25W G4 20W 110V/230V 12V IP54 F CE

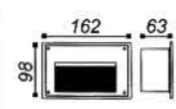

Technical drawings for LED-2101 and LED-2102. LED-2101 dimensions: 111mm width, 44mm height, 51mm depth. LED-2102 dimensions: 170mm width, 68mm height, 86mm depth. Text: Alu.body + S.at cover LED 110V/230V 12V IP54 F CE



LED-2101



LED-2102



LED-2201



LED-2202



LED-2203



LED-2103



LED-2104



LED-2105



LED-2106



LED-2204



LED-2205



LED-2206

Alu.body + S.at cover LED 110V/230V 12V IP54 F CE

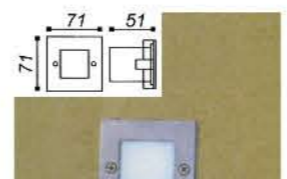

LED-2301



LED-2302



LED-2303

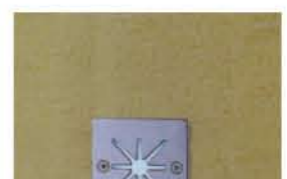

LED-2304

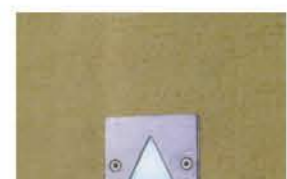

LED-2305



LED-2306



LED-2307



LED-2308



LED-2309



LED-2310



LED-2311

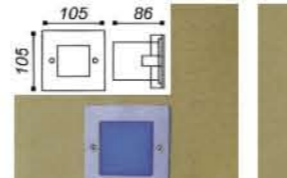

Alu body + S.s.cover LED 110W/230V/12V IP65 F CE

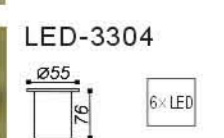
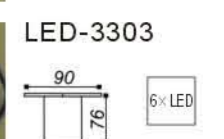
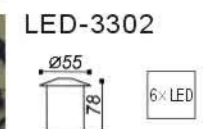
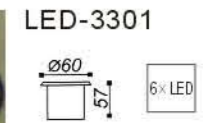
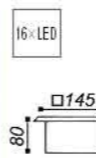
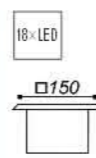
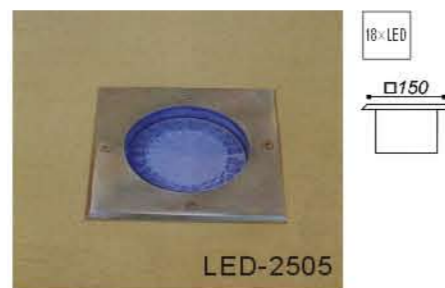
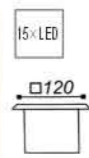
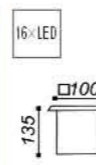
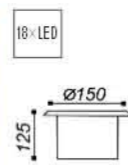
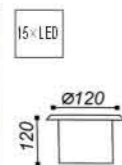
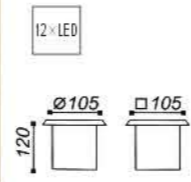
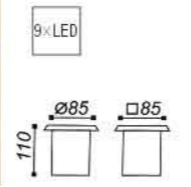
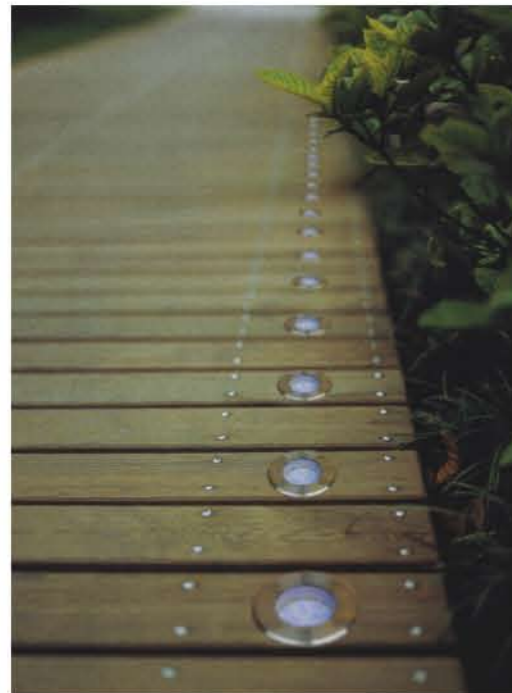



**DESCRIPTION**

Aluminium die casting body  
 Clear glass diffuser  
 Lampholder: Gu5.3  
 Anti-corrosion powder coating finishing  
 For both commercial and industrial use

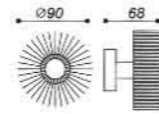

GL-1001



GL-1001A

**DESCRIPTION**

Aluminium die casting  
 Temper glass lens  
 Voltage: 12V  
 Voltage: 220V-240V 50Hz/110V-130V 60Hz  
 G9 max: 25W

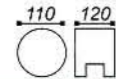

GL-0020-B



GL-0020-A



GL-1101

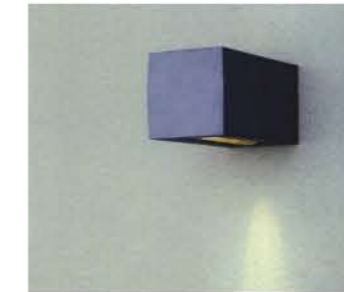

GL-1102

**DESCRIPTION**

Aluminium die casting body  
 Premier clear crystal lens  
 Silicon gasket  
 Lampholder: G9  
 Powder coating with anti-corrosion feature  
 For commercial use

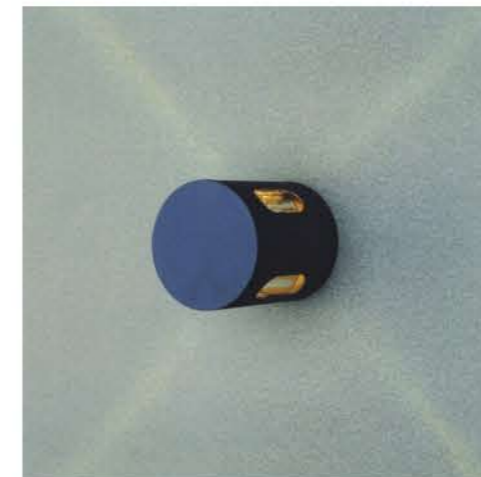
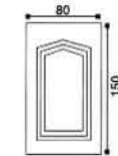

GL-1201

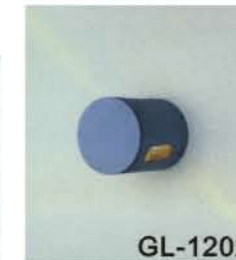

GL-1202

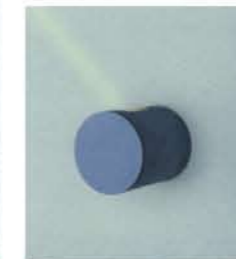

GL-1203

**DESCRIPTION**

Aluminium die casting body  
 Premier clear crystal lens  
 Silicon gasket  
 Lampholder: G9  
 Powder coating with anti-corrosion feature  
 For commercial use

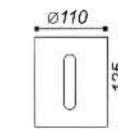

GL-1301



GL-1302

**DESCRIPTION**

Aluminium die casting body  
 Tempered glass diffuser  
 Silicon gasket  
 Lampholder: G9  
 Powder coating with anti-corrosion feature  
 For commercial use

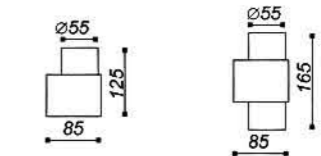
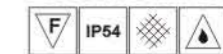



LED-3001



LED-3002



LED-3003



LED-3004



LED-3005



LED-3006

**DESCRIPTION**

Aluminium die casting body  
Superb polishing treatment  
Silicon gasket  
Frost glass or PC diffuser  
Transparent powder coating finishing  
For both home and commercial use

9	220240
LEDS	V

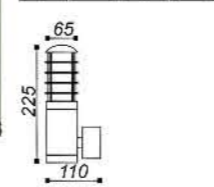

**DESCRIPTION**

Aluminium die casting  
Frost glass diffuser  
Voltage: 220V-240V 50Hz/110V-130V 60Hz  
E27 max: 11W

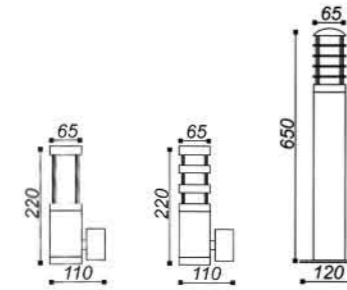

GL-0026-G



GL-0026-C



GL-0041-B



GL-0041-A



GL-0026-A



GL-0026-E



GL-0026-B



GL-0026-C



GL-0026-D

**DESCRIPTION**

Aluminium die casting body  
Frost glass diffuser  
Silicon gasket  
Lampholder: E27  
Powder coating with anti-corrosion feature  
For both home and commercial use  
Available with motion detector

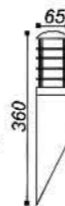

GL-0026-GB



GL-0026-GA



GL-0026-EA



GL-0026-FA



GL-0026-FB



GL-0026-F

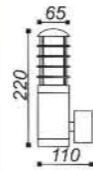

**DESCRIPTION**

Aluminium die casting  
Frost glass diffuser  
Voltage: 220V-240V 50Hz/110V-130V 60Hz  
E27 max: 11W



**DESCRIPTION**

Aluminium die casting  
Temper glass lens  
Voltage: 220V-240V 50Hz/110V-130V 60Hz  
GU10 max: 50W  
Voltage: 12V  
GU5.3 max: 35W

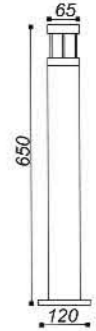
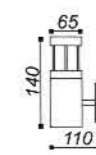
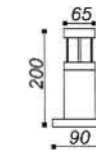

GL-0040-B



GL-0040-C



GL-0040-A



GL-0026-HA



GL-0026-HB



GL-0026-H

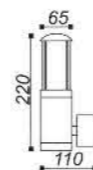

**DESCRIPTION**

Aluminium die casting  
Clear glass diffuser  
Voltage: 220V-240V 50Hz/110V-130V 60Hz  
E27 max: 60W

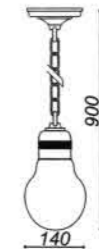
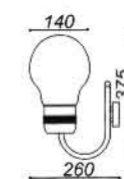

GL-1404



GL-1401



GL-1402



GL-1403

**DESCRIPTION**

Aluminium die casting body  
 Tempered glass diffuser  
 Silicon gasket  
 Lampholder: Gu10 or Gu5.3  
 Supreme polishing treatment + transparent power coating  
 For both home and commercial use

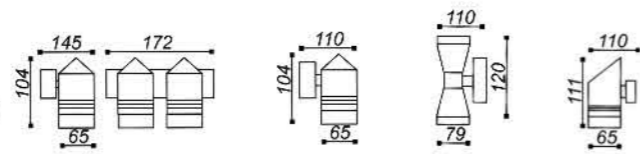

GL-1511

GL-1512

GL-1513

GL-1514

**DESCRIPTION**

Aluminium die casting  
 Frost glass diffuser  
 Voltage: 220V-240V 50Hz/110V-130V 60Hz  
 GL0021-B/GL0022-B: E14 max. 40W  
 GL0021-C/GL0022-C: E27 max. 11W

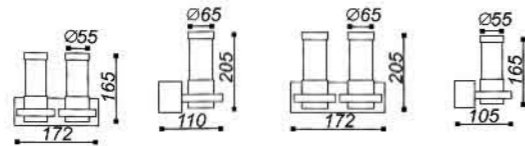

GL-0022-C



GL-0021-C



GL-0021-B



GL-0022-B

**DESCRIPTION**

Aluminium die casting  
 Frost glass diffuser  
 Voltage: 220V-240V 50Hz/110V-130V 60Hz  
 E27 max: 11W

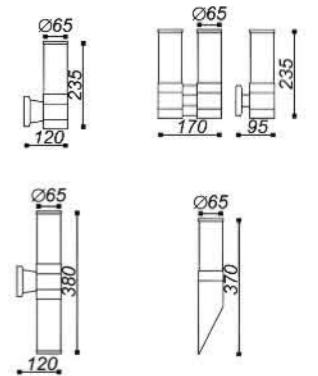

GL-1601



GL-1602



GL-1603



GL-1604



GL-1605



GL-0023-DA

**DESCRIPTION**

Aluminium die casting  
 Frost glass diffuser  
 Voltage: 220V-240V 50Hz/110V-130V 60Hz  
 E27 max: 100W

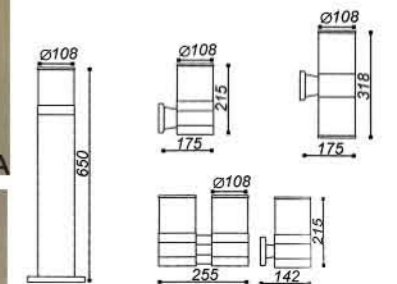

GL-0023-D



GL-0025-A



GL-0024-D

**DESCRIPTION**

Aluminium die casting  
Temper glass lens  
Voltage: 220V-240V 50Hz/110V-130V 60Hz  
E27 max: 100W

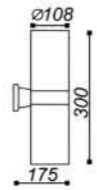

**DESCRIPTION**

Aluminium die casting  
Frost glass / temper glass  
Voltage: 220V-240V 50Hz/110V-130V 60Hz  
E27 max: 60W



**DESCRIPTION**

Aluminium die casting  
Temper glass lens  
Voltage: 220V-240V 50Hz/110V-130V 60Hz  
E27 max: 11W

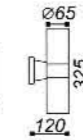
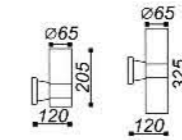

**DESCRIPTION**

Aluminium die casting  
Temper glass lens  
Voltage: 220V-240V 50Hz/110V-130V 60Hz  
GU10 max: 50W

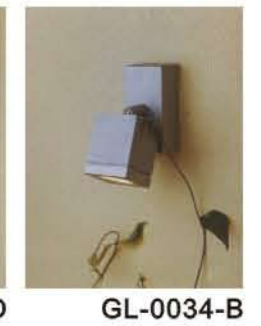

**DESCRIPTION**

Aluminium die casting  
Temper glass lens  
Voltage: 12V  
GU5.3 max: 35W

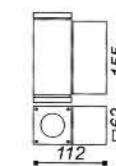
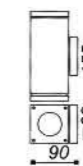
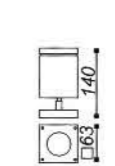



**DESCRIPTION**

Aluminium die casting  
Temper glass lens  
Voltage: 220V-240V 50Hz/110V-130V 60Hz  
GU9 max: 40W

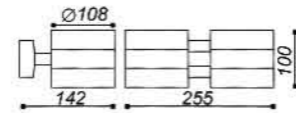
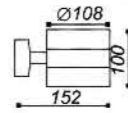

GL-0016-D



GL-0017-D



GL-6005

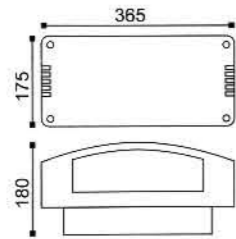

**DESCRIPTION**

Aluminium die casting  
Temper glass lens  
Voltage: 220V-240V 50Hz/110V-130V 60Hz  
Rx7s max: 150W



**DESCRIPTION**

Aluminium die casting  
Crystal glass lens  
Voltage: 220V-240V 50Hz/110V-130V 60Hz  
E27 max: 100W

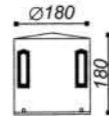

GL-9162



GL-9163



GL-9164



GL-9165

**DESCRIPTION**

Aluminium die casting  
Temper glass lens  
Voltage: 12V  
GU5.3 max: 35W  
Voltage: 220V-240V 50Hz/110V-130V 60Hz  
GU10 max: 50W

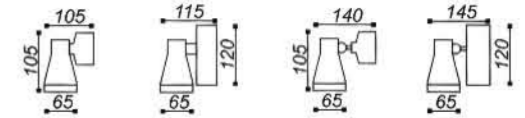

GL-0036-A



GL-0029-A



GL-0029-C



GL-0029-B



GL-0029-D



GL-0036-B



GL-0029-SS



GL-0036-C



GL-0036-B

**DESCRIPTION**

Aluminium die casting  
 Temper glass lens  
 Voltage: 12V  
 GU5.3 max: 35W  
 Voltage: 220V-240V 50Hz/110V-130V 60Hz  
 GU10 max: 50W

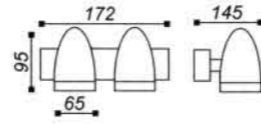
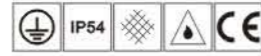

GL-0030-E



GL-0030-SS

GL-0030-B

GL-0030-A



GL-0037



GL-0030-D

GL-0030-C

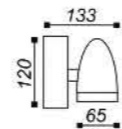
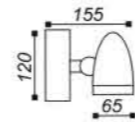

**DESCRIPTION**

Aluminium die casting  
 Temper glass lens  
 Voltage: 12V  
 GU5.3 max: 35W  
 Voltage: 220V-240V 50Hz/110V-130V 60Hz  
 GU10 max: 50W

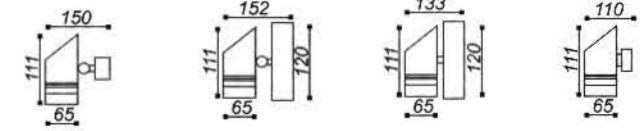

GL-0038-A



GL-0031-A



GL-0031-C



GL-0031-E



GL-0031-D



GL-0038-B



GL-0038-C



GL-0031-B

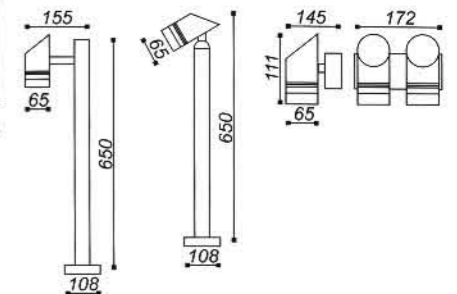

**DESCRIPTION**

Aluminium die casting  
 Temper glass lens  
 Voltage: 12V  
 GU5.3 max: 35W  
 Voltage: 220V-240V 50Hz/110V-130V 60Hz  
 GU10 max: 50W

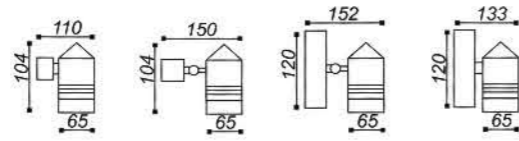
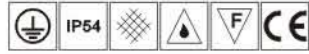

GL-0039-A



GL-0032-A



GL-0032-D



GL-0032-C



GL-0032-B



GL-0039-B



GL-0039-C

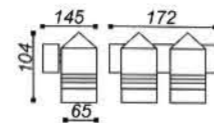

GL-0032-E

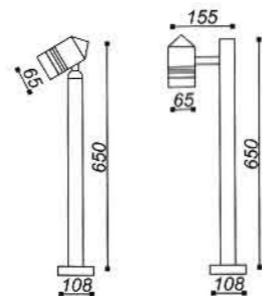

GL-1701



GL-1702



GL-1703



GL-1704

**DESCRIPTION**

Aluminium die casting  
 Temper glass lens  
 Voltage: 12V  
 GU5.3 max: 35W

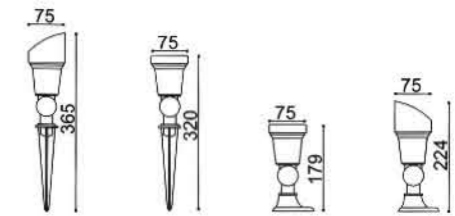

GL-1801

**DESCRIPTION**

Aluminium die casting  
 Temper glass lens  
 Voltage: 220V-240V 50Hz/110V-130V 60Hz  
 GU10 max: 50W  
 Voltage: 12V  
 GU5.3 max: 35W

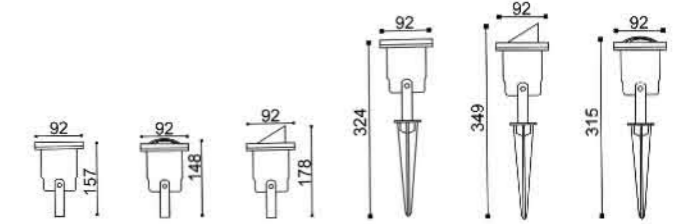

GL-1802



GL-1803



GL-1804



GL-1805



GL-1806



GL-1901



GL-1902



GL-1903



GL-1904

### DESCRIPTION

Stainless steel  
Temper glass lens  
Voltage: 12V  
GU5.3 max: 35W

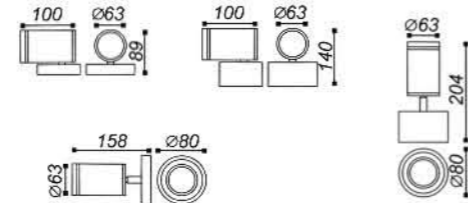

### DESCRIPTION

Stainless steel  
Temper glass lens  
Voltage: 220V-240V 50Hz/110V-130V 60Hz  
GU10 max: 50W

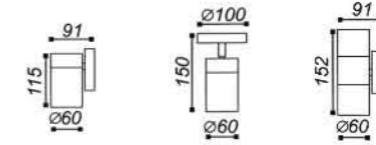

GL-2011



GL-2012



GL-2013



GL-2001



GL-2002

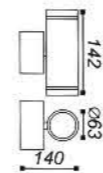

GL-2003

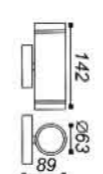

### DESCRIPTION

Aluminium body with stainless steel cover  
Temper glass lens  
with plastic recess box  
Voltage: 220V-240V 50Hz/110V-130V 60Hz  
GU10 max: 50W  
Voltage: 12V  
GU5.3 max: 35W

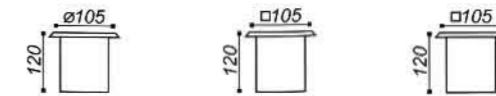

GL-2021



GL-2022



GL-2023



**DESCRIPTION**

Stainless steel  
Temper glass lens  
With plastic recess box  
Voltage: 12V  
GU5.3 max: 35W

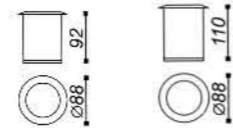

GL-2031

GL-2032



GL-2033

GL-2034

GL-2035

GL-2036



GL-2041



GL-2042



GL-2043



GL-2044

**DESCRIPTION**

Stainless steel  
Temper glass lens  
Voltage: 12V  
GU5.3 max: 35W

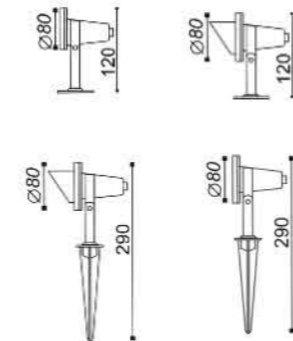

GL-2051



GL-2052



GL-2053

**DESCRIPTION**

Stainless steel  
Temper glass lens



GL-2061

**DESCRIPTION**

Copper  
Frost glass diffuser  
Voltage: 12V  
GU5.3 max: 35W



GL-2062



GL-2063

**DESCRIPTION**

Aluminium die casting  
Temper glass diffuser  
Voltage: 12V  
GU4 max: 20W

